



INFRARED REMOTE CONTROL RECEIVER

■ GENERAL DESCRIPTION

NJL50H/V000 series are small and high performance receiving devices for infrared remote control system. The pulse width of NJL50H/V000 series are stable relating to commander's power or distance between transmitter and receiver. NJL50H/V000 series have five kinds of package including three types of metal case to meet the various applications.

■ FEATURES

1. Mold type and metal case type to meet the design of front panel.
2. Elliptic lens to improve the characteristic against light noise from the upper and lower side.
3. Line-up for various center carrier frequencies.

■ APPLICATIONS

1. AV instruments such as Audio, TV, VCR, CD, MD, etc.
2. Home appliances such as Air-conditioner, Fan, etc.
3. The other equipments with wireless remote control.

■ LINE-UP

Mold/ Metal Case	Mold Type		Metal Case Type		
	Top	Side	Top		
View Carrier Frequency	Height 5.4 mm	6.3 mm	8 mm	11 mm	15 mm
fo=30 KHz	NJL51H300	NJL51V300	NJL57H300	NJL55H300	NJL56H300
32.75KHz	NJL51H328	NJL51V328	NJL57H328	NJL55H328	NJL56H328
36 KHz	NJL51H360	NJL51V360	NJL57H360	NJL55H360	NJL56H360
36.7 KHz	NJL51H367	NJL51V367	NJL57H367	NJL55H367	NJL56H367
38 KHz	NJL51H380	NJL51V380	NJL57H380	NJL55H380	NJL56H380
40 KHz	NJL51H400	NJL51V400	NJL57H400	NJL55H400	NJL56H400
56.8 KHz	NJL51H568	NJL51V568	NJL57H568	NJL55H568	NJL56H568

※ Regarding the other frequencies or packages, please contact to NJRC individually.

■ BLOCK DIAGRAM

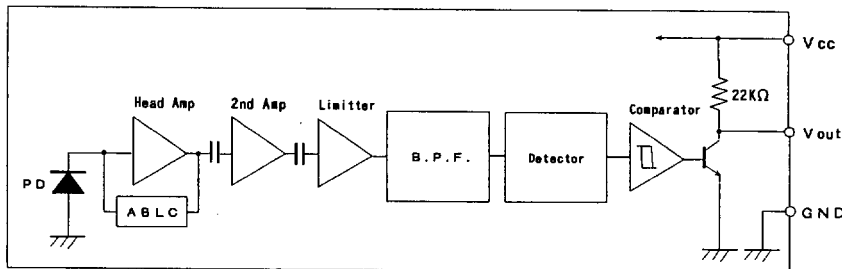

■ ABSOLUTE MAXIMUM RATINGS (Ta= 25 °C)

Supply Voltage	V _{cc}	6.3V
Operating Temperature Range	T _{opr}	-30 °C - +85 °C
Storage Temperature Range	T _{stg}	-40 °C - +85 °C
Soldering Temperature	T _{sol}	260 °C 5sec 4.0mm from mold body

6



RECOMMENDED OPERATING CONDITION

Supply Voltage Range V_{cc} 4.5V - 5.5V

ELECTRO-OPTICAL CHARACTERISTICS ($V_{cc} = 5.0V$, $T_a = 25^\circ C$)

PARAMETER	SYMBOL	TEST CONDITION	MIN	TYP	MAX	UNIT
Supply Current	I_{cc}	No Signal Input	—	—	3	mA
Transmission Distance	L_c	Direction of Ray Axis *1	8	16	—	m
Directivity	θ_L	Angle of half L_c , Horizontal *2	—	50	—	deg
	θ_V	Angle of half L_c , Vertical *2	—	35	—	deg
Output Voltage Low	V_L	No Load	—	0.2	0.5	V
Output Voltage High	V_H	No Load	4.5	—	—	V
Low Level Pulse Width	T_{WL}	See Test Circuit	400	—	800	μs
High Level Pulse Width	T_{WH}	See Test Circuit	400	—	800	μs
Center Frequency	f_o	See Line-up	30.0	—	56.8	KHz

Note *1: Test with each center carrier frequency under the test condition shown below.

*2: Place major axis of elliptic lens in horizontal direction and minor in vertical.

TEST METHOD

Test condition is as follows:

(1) Standard Transmitter:

Transmitting waveform is shown in Fig.1. Transmitting power should be adjusted so that output voltage V_{out} will be 400 mVp-p.

Regarding IR LED used for transmitter,
 $\lambda_p = 940nm$, $\Delta\lambda = 50nm$.

Regarding photo diode, Sensitivity
 $S = 26nA/Lx$, in case light source temperature $2856^\circ K$, $E_e = 100Lx$, $VR = 5V$

(2) Test system: Shown in Fig.3.

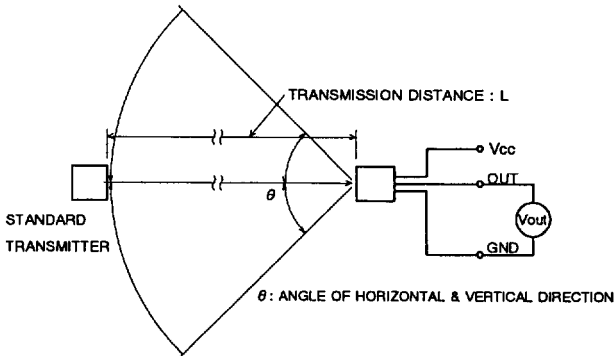

Fig. 3 TEST SYSTEM

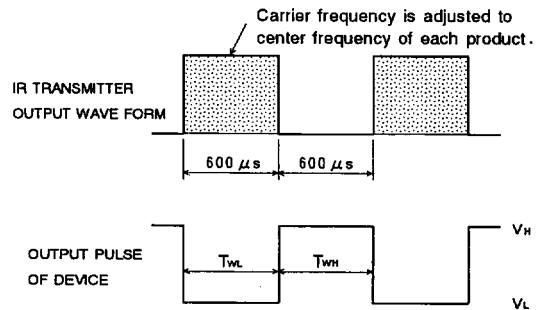

Fig. 1 TRANSMITTER WAVE FORM

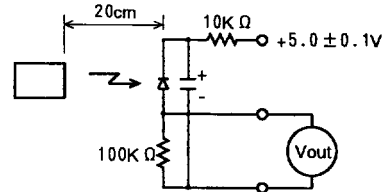
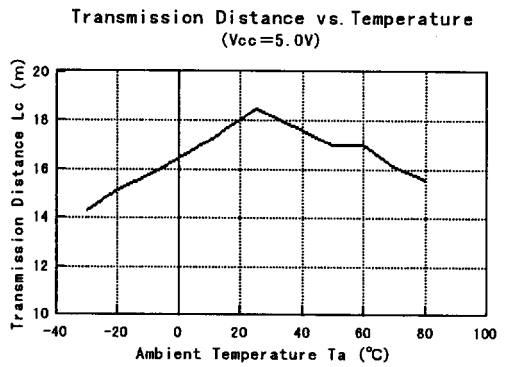
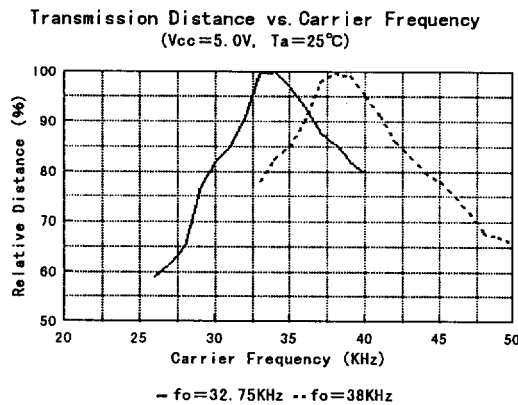
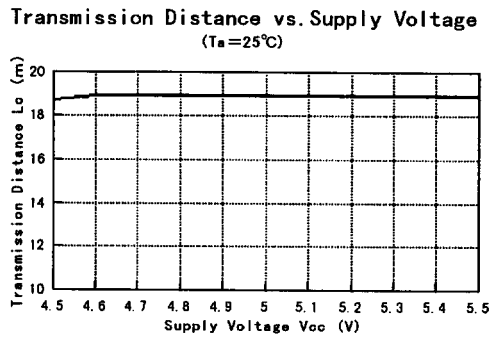
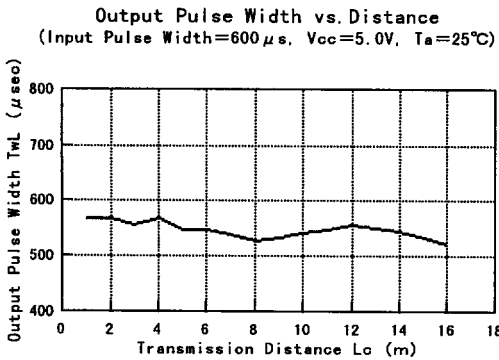
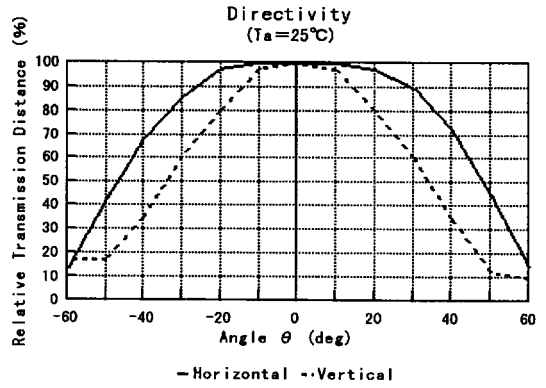
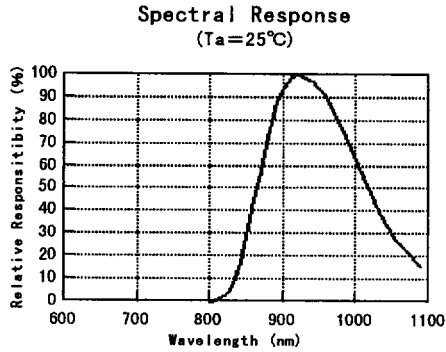

Fig. 2 STD. TRANSMITTER TEST CIRCUIT

6



■ TYPICAL CHARACTERISTICS



6



RECOMMENDED APPLICATION CIRCUIT

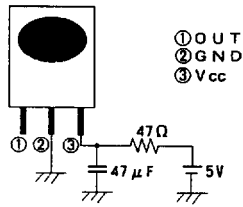

RC Filter should be connected closely between Vcc pin and GND pin.

OUTLINE

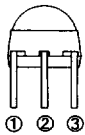
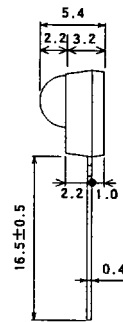
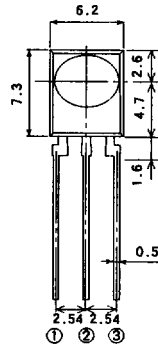
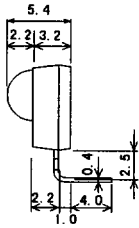
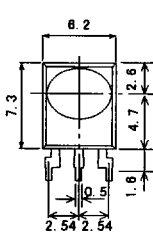

① OUT
② GND
③ Vcc



① OUT
② GND
③ Vcc

NJL51H000
UNIT : mm

NJL51V000
UNIT : mm

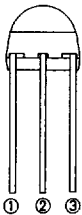
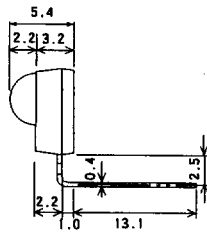
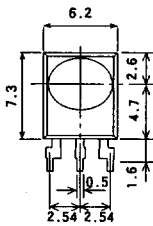

① OUT
② GND
③ Vcc

NJL51H000F3
UNIT : mm

6

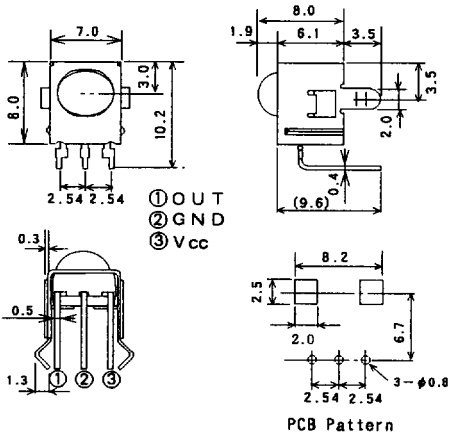

NJL57H000
UNIT : mm

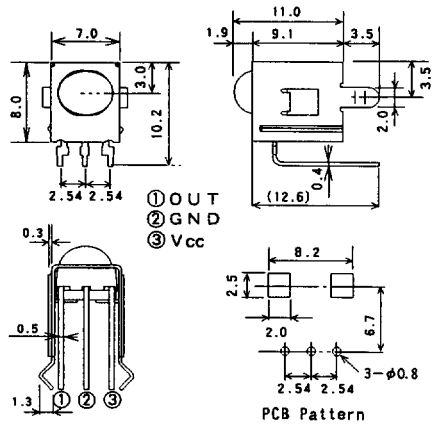

NJL55H000
UNIT : mm

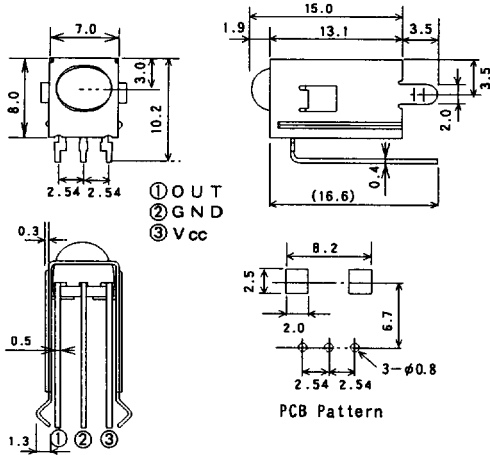

NJL56H000
UNIT : mm

1. Tolerance is $\pm 0.3\text{mm}$ unless otherwise noted.
2. Ground metal case on PCB. Metal case is not connected to GND pin inside.